

## 200-201 Chamfered Engraved Demarcation Stud



Above. Shown with polished finish

### Description

Manufactured from 316 grade steel.  
Satin polish finish as standard.  
Constructed from non corrosive material. Long Service life. Comes with a chamfered edge. Engraved top.

### Dimensions

25mm $\varnothing$  x 30mm x 5mm thick top  
M8 thread

### Options

Etched or polished finish  
Sizes 40, 50, 75, 90, 105 and 120mm  
Smooth topped version suitable for off-highway use such as car parks  
Full installation service

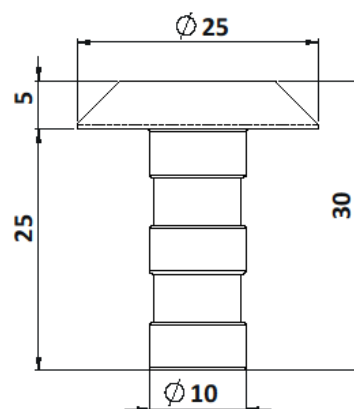
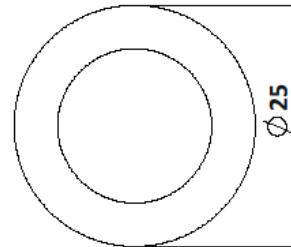

# Studmarc Installation Guide

## Hole Drilling

- Drill hole in the substrate to the required embedment depth using the appropriately sized carbide drill bit.

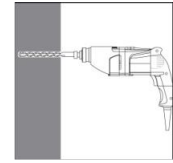

## Manual Air Cleaning

- The manual air pump shall be used for blowing out the debris that has built up in the holes from drilling. Blow out at least **4** times from the back of the hole, using an extension if needed.
- Brush **4** times with the specified brush size by inserting the steel brush to the back of the hole (if needed with extension) in a twisting motion.
- Blow out again with manual pump at least **4** times.

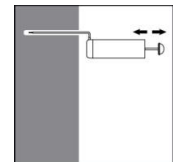
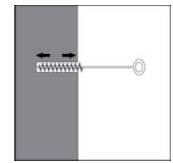
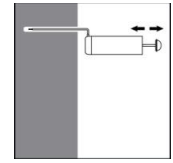

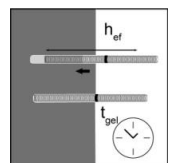
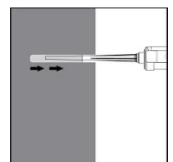
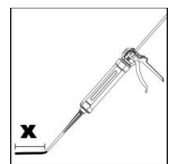
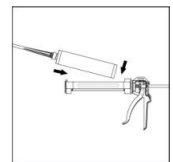
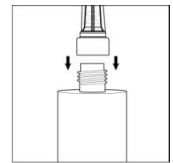

## Injection & Installation of Stud

- Remove the threaded cap from the cartridge. Cut open the foil bag if necessary. Tightly attach the T-Flow mixing nozzle. Do not modify the mixer in any way. Make sure the mixing element is inside the mixer. Use only the supplied mixer.
- Insert the cartridge into the dispenser gun.
- Discard the initial trigger pulls of adhesive. Depending on the size of the cartridge, an initial amount of adhesive mix must be discarded. Each time when the mixer is changed, new discard of waste is needed until the colour is homogeneous. Discard quantities are 10cm for all cartridges.
- Inject the adhesive starting at the back of the hole, slowly withdrawing the mixer with each trigger pull. Fill holes approximately 2/3 full, to ensure that the annular gap between the anchor and the concrete is completely filled with adhesive along the embedment depth.
- Before installation, verify that the stud is dry and free of contaminants. Proceed to install the stud to the required embedment depth and allow the recommended time for the resin to cure - refer to Minimum Curing Time section on the next page.



# Studmarc Installation Guide

## Installation Data

Threaded rod and rebar	Size	Nominal drill bit diameter $d_o$ (mm)	Steel Brush	Cleaning methods		
		 		Hollow drilling with vacuum cleaner (HDB)	Manual cleaning (MAC)	Compressed air cleaning (CAC)
 <b>Studs</b>	M8	10	12 mm	No cleaning needed	$h_{ef} \leq 80$ mm	Yes
	M10	12	14 mm		$h_{ef} \leq 100$ mm	
	M12	14	16 mm		$h_{ef} \leq 120$ mm	
	M16	18	20 mm		$h_{ef} \leq 160$ mm	
	M 20	22	24 mm		$h_{ef} \leq 200$ mm	
	M 24	28	30 mm		$h_{ef} \leq 240$ mm	
 <b>Rebar</b>	$\phi$ 8 mm	12	14 mm	No cleaning needed	$h_{ef} \leq 80$ mm	Yes
	$\phi$ 10 mm	14	16 mm		$h_{ef} \leq 100$ mm	
	$\phi$ 12 mm	16	18 mm		$h_{ef} \leq 120$ mm	
	$\phi$ 14 mm	18	20 mm		$h_{ef} \leq 140$ mm	
	$\phi$ 16 mm	20	22 mm		$h_{ef} \leq 160$ mm	
	$\phi$ 20 mm	24	28 mm		$h_{ef} \leq 200$ mm	
	$\phi$ 25 mm	32	34 mm		$h_{ef} \leq 240$ mm	

## Minimum Curing Time

Minimum base material temperature $C^\circ$	Resin (working time) In dry/wet concrete	Curing time in dry concrete	Curing time in wet concrete
$0^\circ C \leq T_{base\ material} < 10^\circ C$	20 min	90 min	180 min
$10^\circ C \leq T_{base\ material} < 20^\circ C$	9 min	60 min	120 min
$20^\circ C \leq T_{base\ material} < 30^\circ C$	5 min	30 min	60 min
$30^\circ C \leq T_{base\ material} \leq 40^\circ C$	3 min	20 min	40 min